

Alberi PitAgorici

Modello di Francesco Mancini

Disegni di Francesco Mancini/ Francesco Decio

1

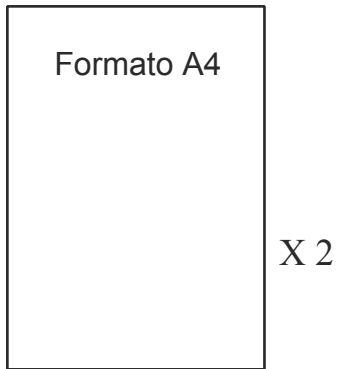

2

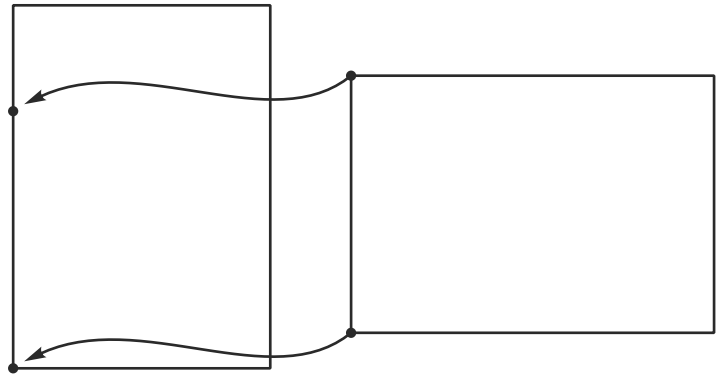

3

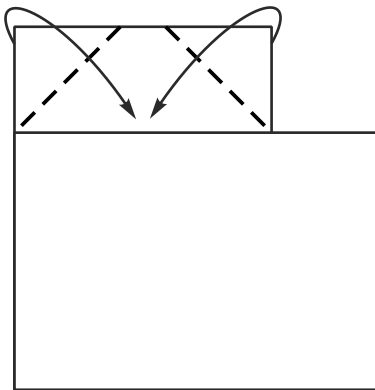

4

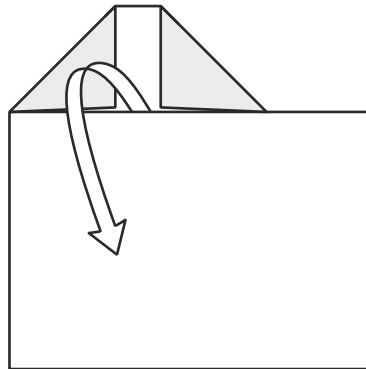

5

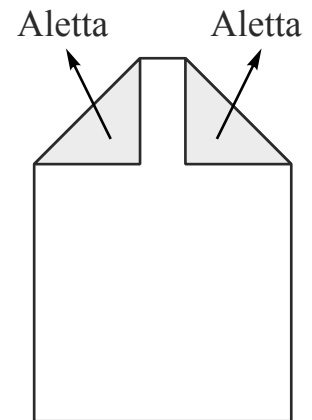

Primo pezzo
terminato

6

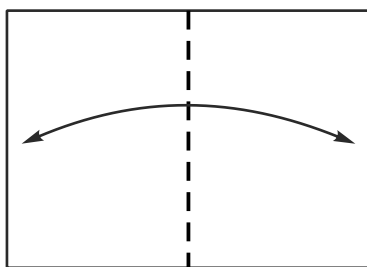

7

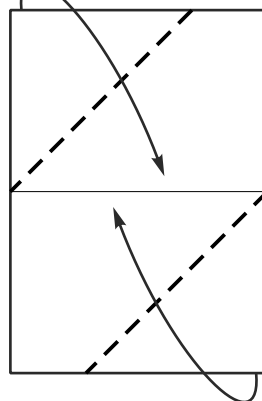

8

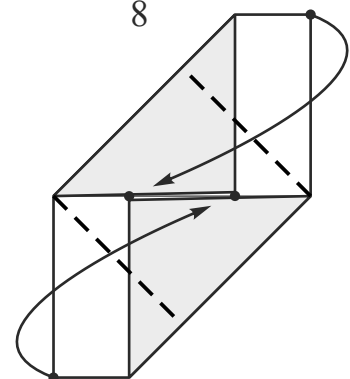

9

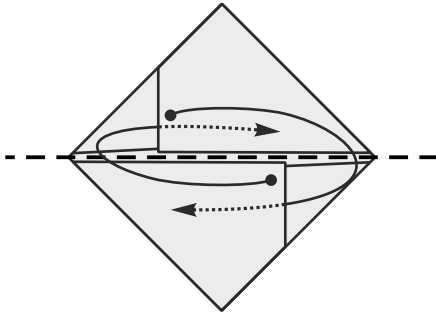

Chiudere incastrando le due alette una nell'altra

10

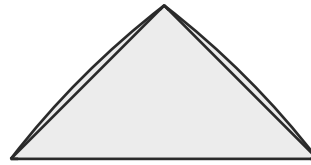

Secondo pezzo terminato

Unione dei due pezzi

11

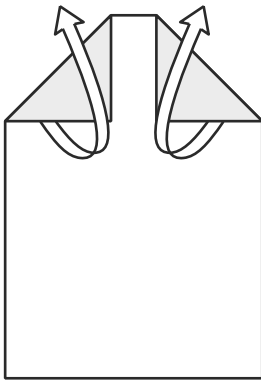

12

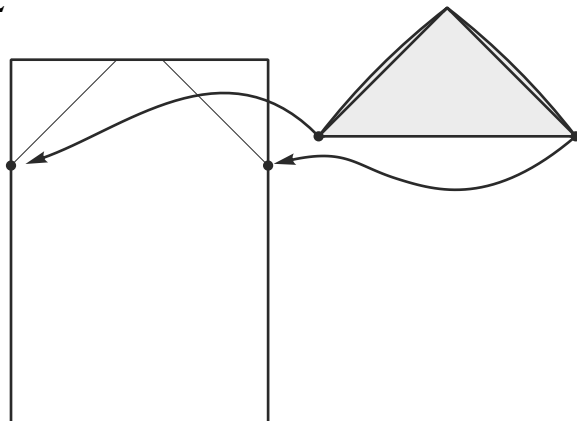

13

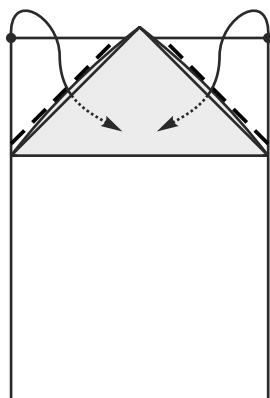

Intascare

14

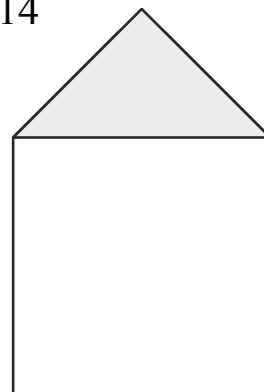

Finito

1

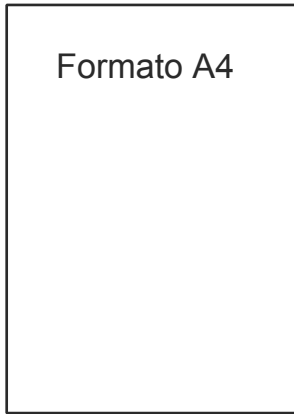

2

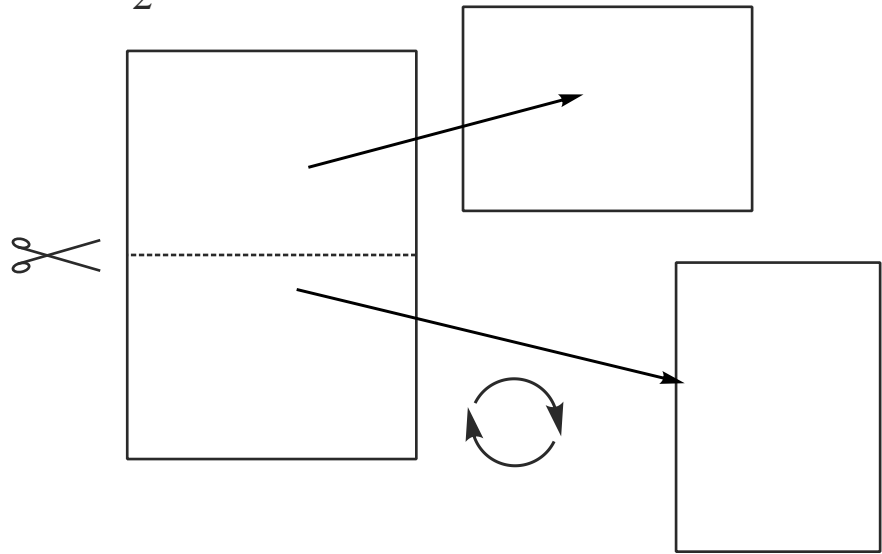

3



Formato A5

4

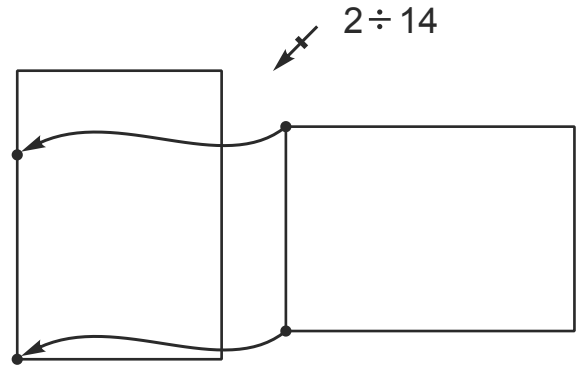

5

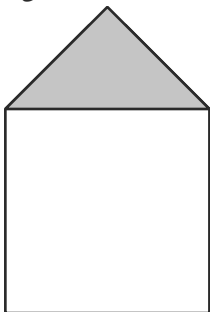

X 2

Accostare i due pezzi a quello fatto in precedenza

6

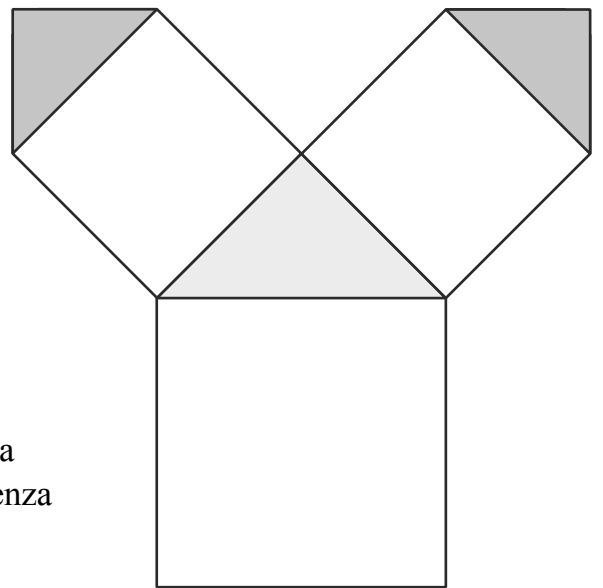

Primo livello finito

1



2

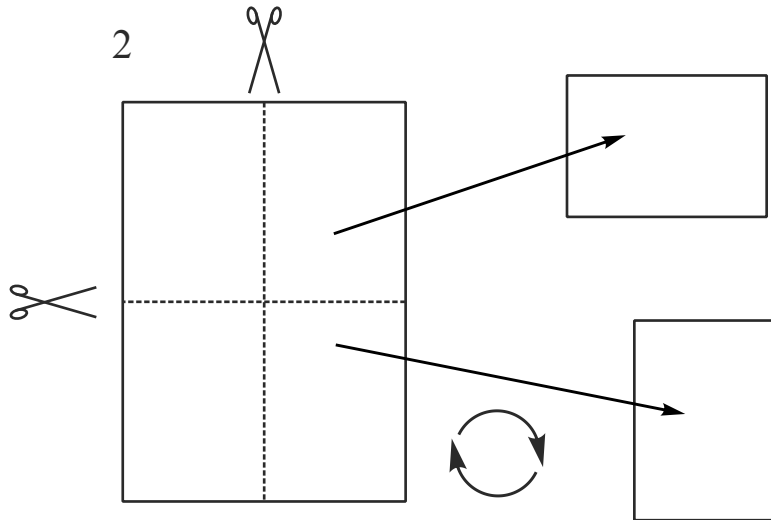

3

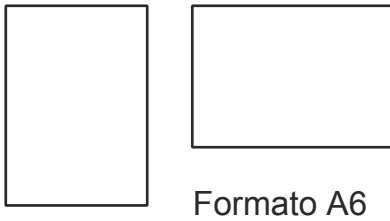

4

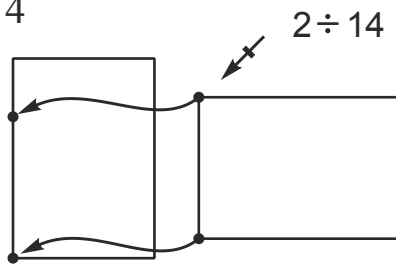

5

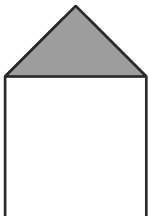

X 4

Accostare i quattro pezzi a quelli fatti in precedenza

6

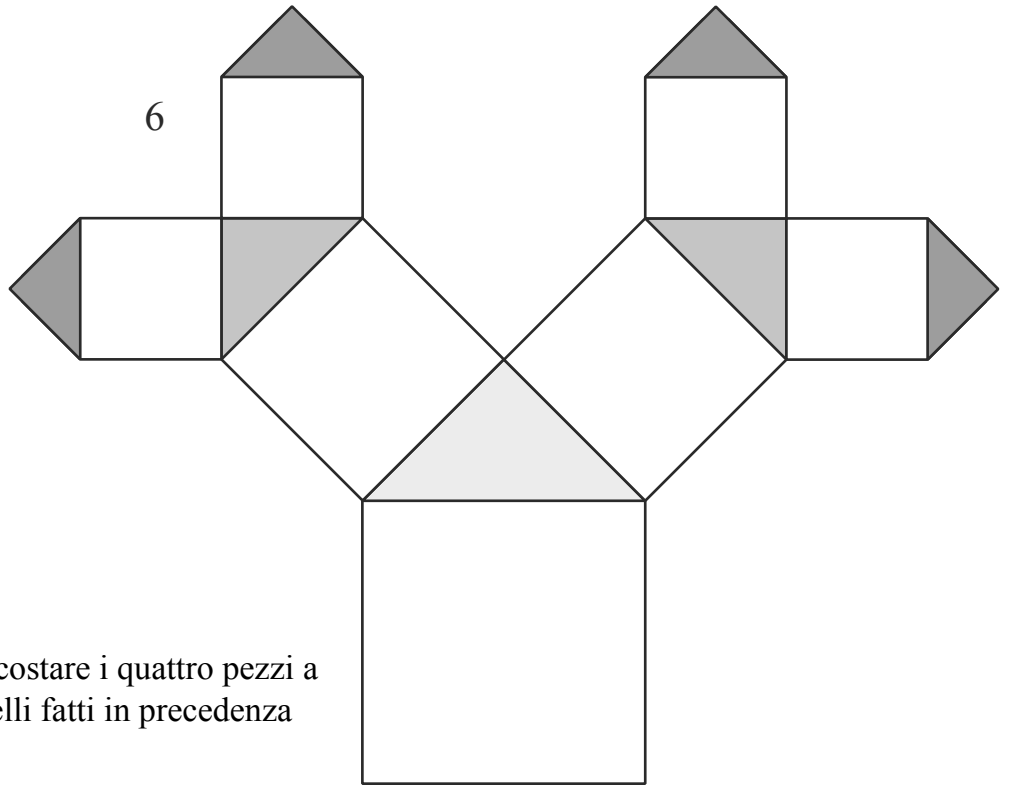

Secondo livello finito

1



2

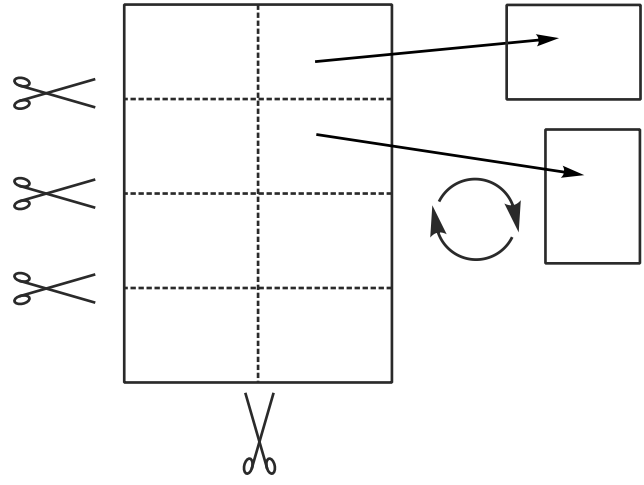

3

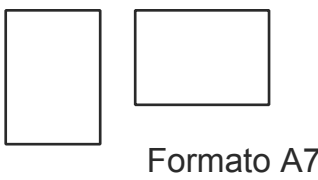

4

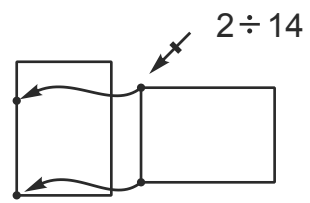

5

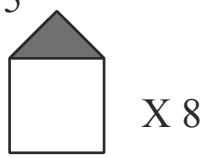

6

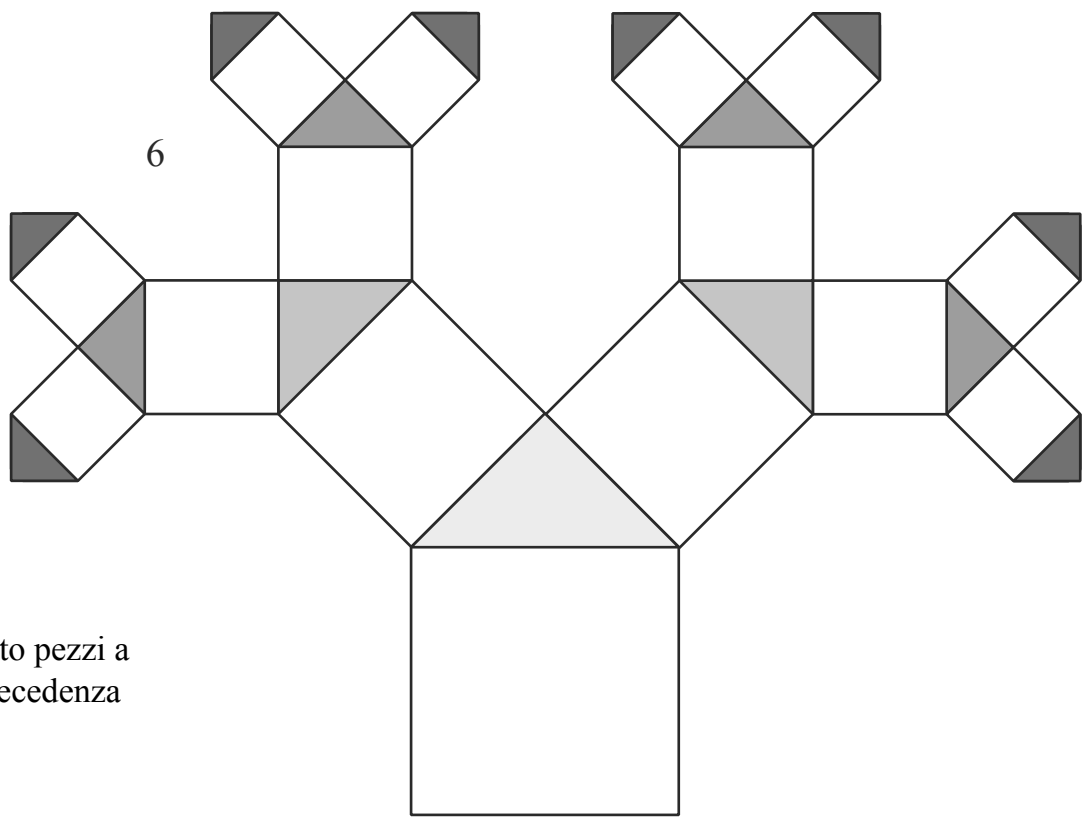

Accostare gli otto pezzi a quelli fatti in precedenza

Terzo livello finito

e così via...

Altri utilizzi del pezzo triangolare

